

ACB  
*Vento!*

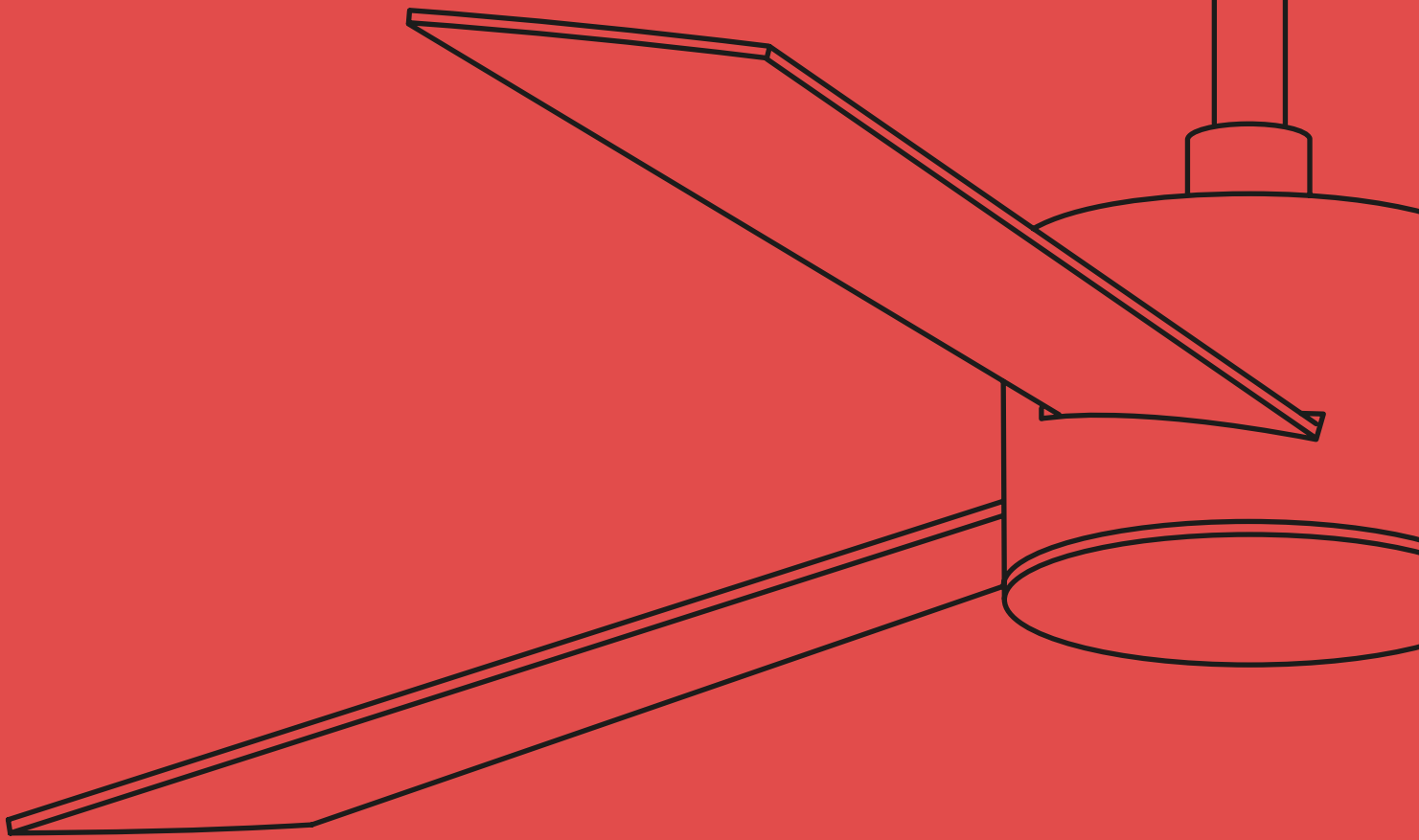

**2025**

Ventiladores | Fans | Ventilateurs | Ventilatoren | Ventilatori



# CÓMO ELEGIR TU VENTILADOR

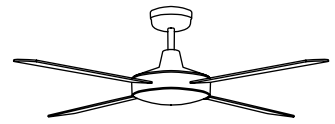

  
 $\leq 15\text{m}^2$   
 $\text{Ø} \leq 107\text{cm}$

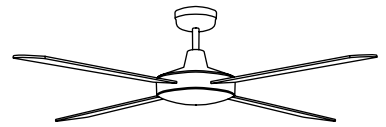

  
 $\leq 13-18\text{m}^2$   
 $\text{Ø} \leq 107-132\text{cm}$

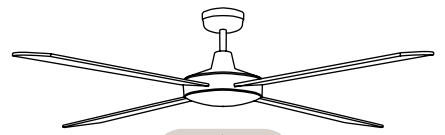

  
 $> 18\text{m}^2$   
 $\text{Ø} > 132\text{cm}$

- How to choose your fan • Comment choisir votre ventilateur •
- Auswahl des geeigneten ventilators • Come scegliere il suo ventilatore •

## LUZ

Light • Lumière • Licht • Luce



### Sin luz

Without light • Sans lumière • Ohne Licht • Senza luce

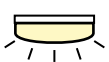

### Con luz LED

With LED light • Avec lumière LED • Mit LED-licht • Con luce LED

## ASPAS

Blades • Pales • Schaufeln • Pale



### La cantidad de aire depende de la inclinación de las aspas, no del número de ellas.

The air flow depends on the inclination of the blades, not on the number of them.

Le débit d'air dépend de l'inclinaison des pales et non du nombre d'entre elles.

Der Luftstrom hängt von der Neigung der Schaufeln ab, nicht von deren Anzahl.

Il flusso dell'aria dipende della inclinazione delle pale, non dalla quantità.

# FUNCIÓN VERANO - INVIERNO

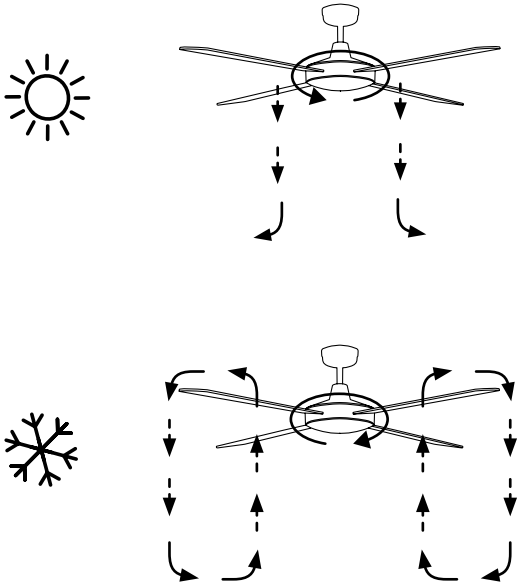

Function summer - winter • Fonction été - hiver •  
Funktion Sommer - Winter • Funzione estate - inverno

## MOTOR

Motor • Moteur • Motor • Motore

**AC**  
MOTOR

### Corriente alterna con 3 velocidades

Alternating current with 3 speeds.  
Courant alterne avec 3 vitesses.  
Wechselstrom mit 3 Geschwindigkeiten.  
Corrente alterna con 3 velocità.

**DC**  
MOTOR

### Corriente continua con 6 velocidades

Direct current with 6 speeds.  
Courant continu avec 6 vitesses.  
Gleichstrom mit 6 Geschwindigkeiten.  
Corrente continua con 6 velocità.

ABS

### ABS es un tipo de plástico muy resistente y aerodinámico

ABS is a kind of plastic, very resistant and aerodynamic.  
ABS est un type de plastique très résistant et aérodynamique  
ist eine Art Kunststoff, sehr widerstandsfähig und aerodynamisch.  
ABS è una specie di plastica, molto resistente e aerodinamica.

PC

### PC es un tipo de plástico muy resistente y transparente

PC is a kind of plastic, very resistant and transparent.  
PC est un type de plastique très résistant et transparent.  
PC ist eine Art Kunststoff, sehr widerstandsfähig und transparent.  
PC è una specie di plastica, molto resistente e trasparente.

PLYWOOD

### Contrachapado es un derivado de la madera con mucha resistencia

Plywood is a very resistant material derived from wood.  
Contre-plaqué est un dérivé du bois très résistant.  
Sperrholz ist ein sehr widerstandsfähiges Material, das aus Holz erzeugt wird.  
Compensato è un materiale molto resistente derivato dal legno.

WOOD

### Las aspas de madera son mas silenciosas

Wooden Blades are quieter.  
Les pales en bois sont plus silencieuses.  
Hölzerne Schaufeln sind leiser.  
Le pale di legno sono più silenziose.

## MATERIAL















































































Material • Matériel • Material • Materiale

# ÍNDICE

Index / Indice / Index / Indice

NOMBRE	DIBUJO	IP	MOTOR				LUZ			
			Grado IP	Tipo	Potencia	Velocidades	Función	Luz	Steps   Kelvin	Lumens
ZONDA		IP44	DC MOTOR	33W	6			3 Steps 3000K 4000K 6000K	4000	LED 47W
BORA		IP44	DC MOTOR	30W	6			3 Steps 3000K 4000K 6000K	2000	LED 20W
BARINE		-	DC MOTOR	32W	6			3 Steps 3000K 4000K 6000K	2300	LED 24W
BRISA		-	DC MOTOR	30W	6			3000K	1140	LED 15W
BISE		-	DC MOTOR	35W	6			3 Steps 3000K 4000K 6500K	2400	LED 24W
SHAMAL		-	DC MOTOR	35W	6			3 Steps 3000K 4000K 6500K	2200	LED 22W
GARBIN		-	DC MOTOR	30W	6			-	-	-
SIROCO		-	DC MOTOR	35W	6			-	-	-
	<i>Kit Luz (*)</i>	-	-	-	-			3 Steps 3000K 4000K 6500K	2200	LED 22W
ROK		-	DC MOTOR	32W	6			-	-	-
	<i>Kit Luz (*)</i>	-	-	-	-			3 Steps 3000K 4000K 6500K	1200	LED 18W
GREGAL		-	DC MOTOR	35W	6			-	-	-
	<i>Kit Luz (*)</i>	-	-	-	-			3 Steps 3000K 4000K 6500K	1800	LED 18W

(\*) Kit Luz no incluido en el producto, pedir por separado

TAMAÑO		PESO	AIRFLOW	ASPAS			MANDO		COLOR	CÓDIGO	PÁG.
Diámetro	Estancia	Kg	Flujo de aire	Número y forma	Material	Reversibles	Sí/No	Temporizador		SKU	Nº
Ø48/107cm 18.9/42"	 ≤13-18m <sup>2</sup>	 7.6Kg	 102 m <sup>3</sup> /min 3600 CFM		ABS	-				V25144232B	6-7
Ø132cm 52"	 ≤13-18m <sup>2</sup>	 5.2	 185 m <sup>3</sup> /min 6533CFM		ABS	-				V2516523B	8-9
Ø132cm 52"	 ≤13-18m <sup>2</sup>	 6.8	 166 m <sup>3</sup> /min 5865 CFM		ABS	-				V25064231B	10-11
Ø132cm 52"	 ≤13-18m <sup>2</sup>	 5.5	 189 m <sup>3</sup> /min 6677CFM		ABS	-				V2503520B	12-13
Ø92cm 36"	 ≤15m <sup>2</sup>	 5.2	 147 m <sup>3</sup> /min 5200CFM		PLYWOOD	✓				V2521030B	14-15
Ø132cm 52"	 ≤13-18m <sup>2</sup>	 5.5	 168 m <sup>3</sup> /min 5955CFM		PLYWOOD	✓				V2522030B	16-17
Ø132cm 52"	 ≤13-18m <sup>2</sup>	 7.03	 149 m <sup>3</sup> /min 5264 CFM		WOOD	-				V250252XNM	18-19
Ø132cm 52"	 ≤13-18m <sup>2</sup>	 4.86	 152 m <sup>3</sup> /min 5380 CFM		WOOD	-				V2519040B	20-21
-	-	-	-	-	-	-	-	-		K2003030B	
Ø132cm 52"	 ≤13-18m <sup>2</sup>	 4.52	 143 m <sup>3</sup> /min 5055 CFM		WOOD	-			 	V2518040B V2518040N	22-25
-	-	-	-	-	-	-	-	-	 	K2001030B K2001030N	
Ø132cm 52"	 ≤13-18m <sup>2</sup>	 4.6	 154 m <sup>3</sup> /min 5460 CFM		ABS	-			    	V2520040B V2520040N V2520041N K2002030B K2002030N	
-	-	-	-	-	-	-	-	-			





# ZONDA

IP44



OFF



ON

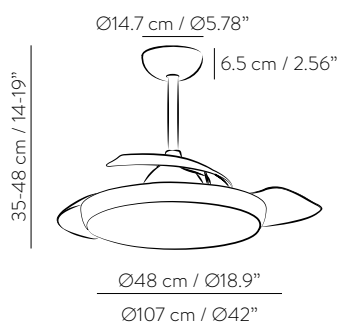

**V25144232B** PVP 219€

<b>Acabado</b>	<input type="checkbox"/> Blanco Mate / Opal	 Flujo amplio
<b>Motor</b>	33W	
<b>Velocidades</b>	1 - 2 - 3 - 4 - 5 - 6	
<b>RPM</b>	161 - 169 - 176 - 189 - 209 - 232	
<b>Decibelios</b>	33,2dB - 35,1dB - 36,7dB - 37dB - 37,3dB - 38,5dB	
<b>Airflow</b>	102m <sup>3</sup> /min   CFM 3600	
<b>Luz</b>	LED 47W   4000lm   <b>3 Steps</b>   3000K - 4000K - 6000K	
<b>Material Cuerpo</b>	Metal / Acrílico	
<b>Material Aspas</b>	ABS	
<b>Peso</b>	7.67 Kg	
<b>Mando</b>		

**DC**  
MOTOR



3 Steps  
3000K  
4000K  
6000K



≤13-18m<sup>2</sup>



15° max



OUTDOOR

12,5 cm / 5"  
25 cm / 10"









# BORA

IP44

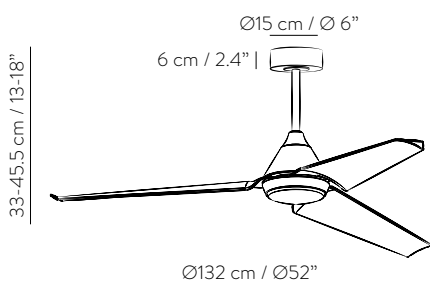

**V2516523B**

**PVP 236€**

**Acabado**

Blanco / Opal

**Motor**

30W

**Velocidades**

1 - 2 - 3 - 4 - 5 - 6

**RPM**

68 - 93 - 110 - 124 - 139 - 150

**Decibelios**

23dB - 30dB - 33dB - 38dB - 42dB - 46dB

**Airflow**

185m<sup>3</sup>/min | CFM 6533

**Luz**

LED 20W | 2000lm | **3 Steps** | 3000K - 4000K - 6000K

**Material Cuerpo**

Metal / Acrílico

**Material Aspas**

ABS

**Peso**

5.2 Kg

**Mando**



**DC**  
MOTOR

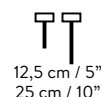
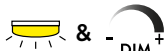





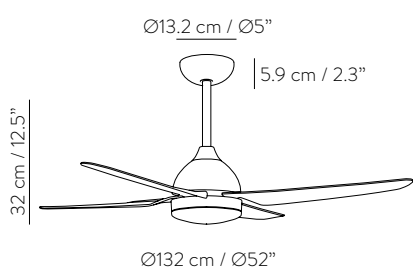

# BARINE



  **V25064231B** **PVP 185€**

<b>Acabado</b>	<input type="checkbox"/> Blanco / Opal
<b>Motor</b>	32W
<b>Velocidades</b>	 1 - 2 - 3 - 4 - 5 - 6
<b>RPM</b>	98 - 131 - 160 - 187 - 219 - 255
<b>Decibelios</b>	42dB - 48dB - 49dB - 57dB - 58dB - 65dB
<b>Airflow</b>	166m <sup>3</sup> /min   CFM 5865
	LED 24W   2300lm   <b>3 Steps</b>   3000K - 4000K - 6000K
<b>Material Cuerpo</b>	Metal / Acrílico
<b>Material Aspas</b>	ABS
<b>Peso</b>	6.8 Kg
<b>Mando</b>	



**DC**  
MOTOR



3000K  
4000K  
3 Steps  
6000K



12,5 cm / 5"  
25 cm / 10"







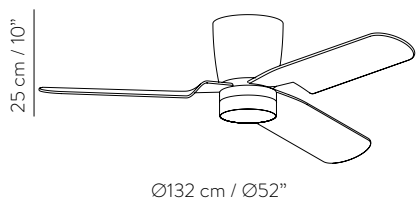

# BRISA



**V2503520B PVP 255.20€**

<b>Acabado</b>	<input type="checkbox"/> Blanco / Opal
<b>Motor</b>	30W
<b>Velocidades</b>	 1 - 2 - 3 - 4 - 5 - 6
<b>RPM</b>	72 - 101 - 127 - 140 - 151 - 187
<b>Decibelios</b>	32,3dB - 33dB - 33,6dB - 34dB - 36,9dB - 40,5dB
<b>Airflow</b>	189m <sup>3</sup> /min   CFM 6677
<b>Luz</b>	LED 15W   1140lm   3000K
<b>Material Cuerpo</b>	Metal / ABS / Cristal
<b>Material Aspas</b>	ABS
<b>Peso</b>	5.5 Kg
<b>Mando</b>	

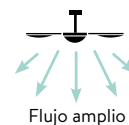





# BISE

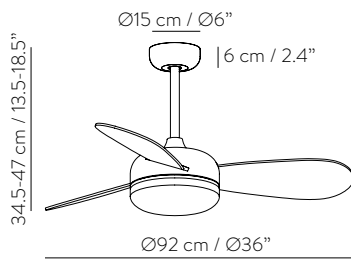

(\*) Longitud de tija de 60cm / 23.6" opcional.

○ 5TIJ0002B PVP 19€

### CONTROLADORES DE PARED COMPATIBLES

BATERIA 2xAAA

AC 220-240V



XCONTROL034  
PVP 29€

XCONTROL035  
PVP 29€

(Medidas ver pagina 30)

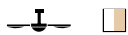

**V2521030B**

**PVP 219€**

<b>Acabado</b>	Blanco / Haya
<b>Motor</b>	35W
<b>Velocidades</b>	1 - 2 - 3 - 4 - 5 - 6
<b>RPM</b>	105 - 140 - 166 - 185 - 205 - 220
<b>Decibelios</b>	36dB - 37dB - 39dB - 41dB - 42dB - 44dB
<b>Airflow</b>	147m <sup>3</sup> /min   CFM 5200
<b>Luz</b>	LED 24W   2400lm   <b>3 Steps</b>   3000K - 4000K - 6500K
<b>Material Cuerpo</b>	Metal
<b>Material Aspas</b>	Plywood
<b>Peso</b>	5.2 Kg
<b>Mando</b>	

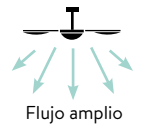

DC MOTOR



3 Steps 3000K 4000K 6500K



≤15m<sup>2</sup>



ASPAS REVERSIBLES

(\*) 12,5 cm / 5" 25 cm / 10"









# SHAMAL

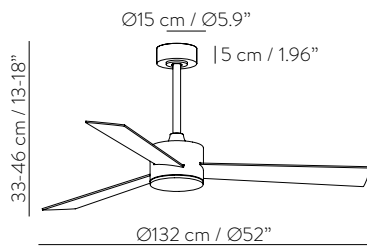

(\*) Longitud de tija de 60cm / 23.6" opcional.

○ 5TIJ0002B PVP 19€

## CONTROLADORES DE PARED COMPATIBLES

BATERIA 2xAAA

AC 220-240V



XCONTROL034  
PVP 29€



XCONTROL035  
PVP 29€

(Medidas ver pagina 30)



V2522030B

PVP 220€

**Acabado**

Blanco / Haya

**Motor**

35W

**Velocidades**

6 1 - 2 - 3 - 4 - 5 - 6

**RPM**

117 - 151 - 180 - 198 - 219 - 230

**Decibelios**

37dB - 38dB - 40dB - 42dB - 43dB - 45dB

**Airflow**

168m<sup>3</sup>/min | CFM 5955

**Luz**

LED 22W | 2200lm | 3 Steps | 3000K - 4000K - 6500K

**Material Cuerpo**

Metal

**Material Aspas**

Plywood

**Peso**

7.03 Kg

**Mando**

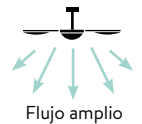

DC  
MOTOR



3000K  
4000K  
6500K  
3 Steps

M  
≤ 13-18m<sup>2</sup>



15° max

ASPAS  
REVERSIBLES

(\*)  
12,5 cm / 5"  
25 cm / 10"





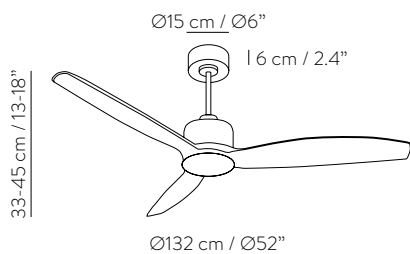

**V250252XNM**

**PVP 299€**

<b>Acabado</b>	Negro / Nogal
<b>Motor</b>	30W
<b>Velocidades</b>	1 - 2 - 3 - 4 - 5 - 6
<b>RPM</b>	63 - 121 - 146 - 165 - 179 - 203
<b>Decibelios</b>	31,5dB - 32dB - 32,5dB - 33,4dB - 36,2dB - 39,7dB
<b>Airflow</b>	149m <sup>3</sup> /min   CFM 5264
<b>Material Cuerpo</b>	Metal
<b>Material Aspas</b>	Madera maciza
<b>Peso</b>	4.86 Kg
<b>Mando</b>	

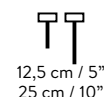
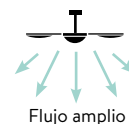





# SIROCO



### CONTROLADORES DE PARED COMPATIBLES

BATERIA 2xAAA

AC 220-240V



XCONTROL034  
PVP 29€

XCONTROL035  
PVP 29€

(Medidas ver pagina 30)

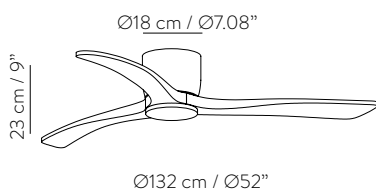

LED 22W | 2200LUM



V2519040B PVP 269€

KIT LUZ opcional



K2003030B PVP 39€

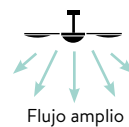

- Acabado** Blanco | Nogal Claro
- Motor** 35W
- Velocidades** 1 - 2 - 3 - 4 - 5 - 6
- RPM** 90 - 109 - 126 - 150 - 170 - 190
- Decibelios** 36dB - 37dB - 39dB - 41dB - 42dB - 45dB
- Airflow** 152m<sup>3</sup>/min | CFM 5380
- Material Cuerpo** Metal
- Material Aspas** Madera maciza
- Peso** 6.3 Kg
- Mando**



# ROK



+ KIT LUZ











# ROK



+ KIT LUZ

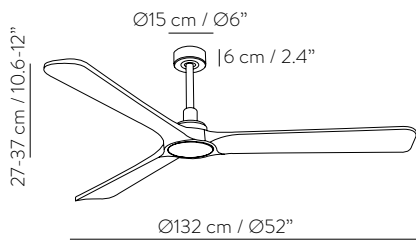

3 Steps LED 18W | 1200LUM

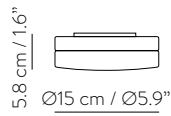

- V2518040B** PVP 239€
- V2518040N** PVP 239€

- KIT LUZ opcional**
- K2001030B** PVP 32€
  - K2001030N** PVP 32€

- Acabado** Blanco | Haya Negro | Nogal
- Motor** 32W
- Velocidades** 1 - 2 - 3 - 4 - 5 - 6
- RPM** 95 - 108 - 123 - 142 - 160 - 182
- Decibelios** 22,5dB - 23,1dB - 30,1dB - 39dB - 41,3dB - 45,6dB
- Airflow** 143m<sup>3</sup>/min | CFM 5055
- Material Cuerpo** Metal
- Material Aspas** Madera maciza
- Peso** 4.52 Kg
- Mando**

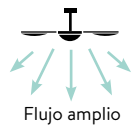

DC MOTOR



≤ 13-18m<sup>2</sup>



12,5 cm / 5"  
25 cm / 10"





# GREGAL





+ KIT LUZ



# GREGAL



### CONTROLADORES DE PARED COMPATIBLES

BATERIA 2xAAA AC 220-240V



XCONTROL034 PVP 29€  
XCONTROL035 PVP 29€

(Medidas ver pagina 30)

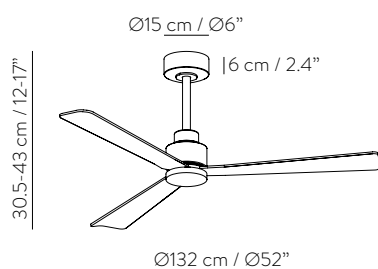

LED 18W | 1800LUM

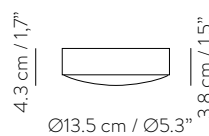

(\*) Longitud de tija de 60cm / 23.6" opcional.

○ 5TIJ0002B ● 5TIJ0002N PVP 19€

	<b>V2520040B</b>	<b>PVP 225€</b>
	<b>V2520040N</b>	<b>PVP 225€</b>
	<b>V2520041N</b>	<b>PVP 225€</b>

	<b>K2002030B</b>	<b>PVP 38€</b>
	<b>K2002030N</b>	<b>PVP 38€</b>

**Acabado** ■■ Negro / Negro ■■ Negro / Nogal □□ Blanco / Blanco

**Motor** 35W

**Velocidades** 1 - 2 - 3 - 4 - 5 - 6

**RPM** 123 - 160 - 188 - 212 - 228 - 243

**Decibelios** 35dB - 36dB - 39dB - 40dB - 42dB - 44dB

**Airflow** 154m<sup>3</sup>/min | CFM 5460

**Material Cuerpo** Metal

**Material Aspas** ABS

**Peso** 4.6 Kg

**Mando**



DC MOTOR









































(\*) 12,5 cm / 5" / 25 cm / 10"



# SIMBOLOGÍA

Symbology / Symbologie / Symbolik / Simbologia

	<b>Negro</b> Black · Noir · Schwarz · Nero		<b>Material de las aspas: ABS</b> Material of the blades: ABS · Matériau des pales: ABS · Material der Schaufeln: ABS · Materiale delle pale: ABS
	<b>Blanco</b> White · Blanc · Weiß · Bianco		<b>Material de las aspas: Policarbonato</b> Material of the blades: Polycarbonate · Matériau des pales: Polycarbonate · Material der Schaufeln: Polycarbonat · Materiale delle pale: Policarbonato
	<b>Opal/Fumé</b> Opal/Smoked · Opale/Fumé · Opal/Fumé · Opale/Fumé		<b>Material de las aspas: Contrachapado</b> Material of the blades: Plywood · Matériau des pales: Contre-plaqué · Material der Schaufeln: Sperrholz · Materiale delle pale: compensato
	<b>Nogal</b> Walnut · Noyer · Walnuss · Noce		<b>Material de las aspas: Madera maciza</b> Material of the blades: Solid Wood · Matériau des pales: Bois solide · Material der Schaufeln: Massivholz · Materiale delle pale: Legno massiccio
	<b>Haya</b> Beech · Hêtre · Buche · Faggio		<b>Aspas reversibles bicolor: blanco mate y madera clara</b> Reversible blades: matt white and pale wood · Pales interchangeable: blanc mat et bois claire · Wendbare Klingen: mattweißes und helles Holz · Pale intercambiabili: bianco opaco e legno chiaro
	<b>Motor AC</b> AC Motor · Moteur AC · AC Motor · Motore AC		<b>Sin luz</b> Without light · Sans lumière · Ohne Licht · Senza luce
	<b>Motor DC</b> DC Motor · Moteur DC · DC Motor · Motore DC		<b>Con luz LED</b> With LED light · Avec lumière LED · Mit LED-Licht · Con luce LED
	<b>Potencia del motor</b> Engine power · Puissance du moteur · Motorleistung · Potenza del motore		<b>Dimable en intensidad de luz (desde el mando)</b> Dimmable light intensity (from the remote control) · Intensité lumineuse réglable (à partir de la télécommande) · Intensità luminosa dimmerabile (dal telecomando)
	<b>6 Velocidades</b> 6 Speeds · 6 Vitesses · 6 Geschwindigkeiten · 6 Velocità		<b>Dimable Kelvin 3000K-4000K-6000K (desde el interruptor de pared)</b> Kelvin Dimmable (from the wall switch) · Dimmable Kelvin (à partir de l'interrupteur mural) · Dimmbar Kelvin (vom Wandschalter) · Dimmerabile Kelvin (desde el interruptor de pared)
	<b>Peso</b> Weight · Le poids · Gewicht · Peso		<b>Lumens</b> Lumens · Lumens · Lumens · Lumens
	<b>Tamaño de la habitación: S</b> Size of the room: S · Taille de la salle: S · Größe des Raumes: S · Dimensione della stanza: S		<b>Temperatura de color</b> Colour temperature · Température de couleur · Farbtemperatur · Temperatura di colore
	<b>Tamaño de la habitación: M</b> Size of the room: M · Taille de la salle: M · Größe des Raumes: M · Dimensione della stanza: M		<b>Potencia de la luz</b> Power of light · Puissance de la lumière · Lichtleistung · Potenza della luce
	<b>Tamaño de la habitación: L</b> Size of the room: L · Taille de la salle: L · Größe des Raumes: L · Dimensione della stanza: L		<b>Mando incluido</b> Remote control included · Télécommande inclus · Fernbedienung enthalten · Telecomando inclusi
	<b>Flujo de aire</b> Airflow · Débit d'air · Luftstrom · Flusso d'aria		<b>Temporizador</b> Timer · Minuterie · Timer · Timer
	<b>3 Aspas</b> 3 Blades · 3 Pales · 3 Schaufeln · 3 Pale		<b>El mando se puede vincular a varios ventiladores</b> The control can be linked to several fans · La commande peut être reliée à plusieurs ventilateurs · The control can be linked to several fans · The control can be linked to several fans
	<b>4 Aspas</b> 4 Blades · 4 Pales · 4 Schaufeln · 4 Pale		<b>2 Tamaños diferentes de tijas</b> 2 Size of rods · 2 Taille de tiges · 2 Stabgröße · 2 dimensioni delle aste
	<b>3 Aspas</b> 3 Blades · 3 Pales · 3 Schaufeln · 3 Pale		<b>Grado de protección IP44</b> Degree of protection · Niveau de protection · Grado di protezione · Schutzart
	<b>Adecuado para techos inclinados</b> Suitable for sloping roof · Convient aux toits en pente · Geeignet für Dachschrägen · Adatto a tetto inclinato		<b>Apto para exterior: IP44</b> Suitable for outdoor use: IP44 · Adapté à l'utilisation en extérieur : IP44 · Geeignet für den Außeneinsatz: IP44 · Adatto all'uso esterno: IP44
	<b>Función verano - invierno</b> Summer - Winter function · Fonction été - hiver · Sommer - Winterfunktion · Funzione estate - inverno		<b>Flujo de aire amplio</b> Ample airflow · Débit d'air important · Reichlich Luftstrom · Ampio flusso d'aria

 **Kit Luz (3000K-4000K-6500K)**  
Light Kit · Kit d'éclairage · Bausatz Licht · Kit luci

 **Control de pared**  
Wall control · Commande murale · Wandsteuerung · Comando a parete

**AC 220-240V**



**BATERIA 2xAAA**



# GRADO DE PROTECCIÓN

Degree of protection / Niveau de protection / Grado di protezione / Schutzart

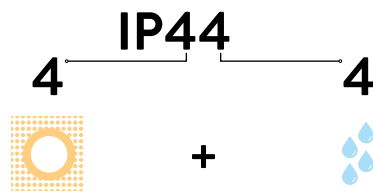
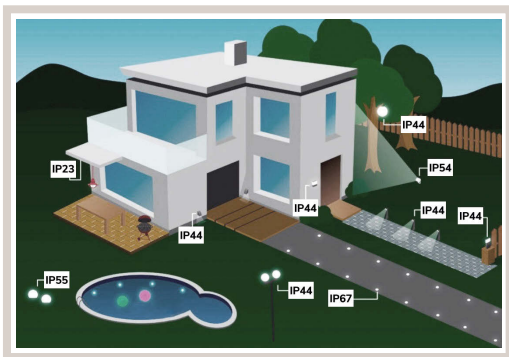

**Índice de protección contra la penetración de partículas sólidas y húmedas**  
 Protection degree offered by the fixture to the ingress of solids and liquids  
 Indice de protection contre la pénétration des corps solides et des liquides  
 Indice di protezione contro la penetrazione di corpi solidi e di liquidi  
 Schutzgrad gegen feste Fremdkörper und Wasser

	1a cifra, protección contra la penetración de cuerpos sólidos	1st figure, protection against penetration by solid bodies	1er chiffre, protection contre la pénétration de corps solide	1a cifra, protezione contro la penetrazione dei corpi solidi	1. Kennziffer: Schutz gegen Eindringen fester Körper
<b>0</b>	Ninguna protección	No protection	Sans protection	Nessuna protezione	Ungeschützt
<b>1</b>	Protección contra cuerpos sólidos de tamaño superior a 50mm	Protected against solid bodies over 50 mm in diameter	Protection contre les corps solides de dimensions supérieures à 50 mm	Protezione contro i corpi solidi di dimensioni superiori a 50mm	Fremdkörper grösser als 50 mm
<b>2</b>	Protección contra cuerpos sólidos de tamaño superior a 12mm	Protected against solid bodies over 12 mm in diameter	Protection contre les corps solides de dimensions supérieures à 12 mm	Protezione contro i corpi solidi di dimensioni superiori a 12mm	Geschützt gegen feste Fremdkörper grösser als 12 mm
<b>3</b>	Protección contra cuerpos sólidos de tamaño superior a 2,5mm	Protected against solid bodies over 2,5 mm in diameter	Protection contre les corps solides de dimensions supérieures à 2,5 mm	Protezione contro i corpi solidi di dimensioni superiori a 2,5mm	Geschützt gegen feste Fremdkörper grösser als 2,5 mm
<b>4</b>	Protección contra cuerpos sólidos de tamaño superior a 1mm	Protected against solid bodies over 1 mm in diameter	Protection contre les corps solides de dimensions supérieures à 1 mm	Protezione contro i corpi solidi di dimensioni superiori a 1mm	Geschützt gegen feste Fremdkörper grösser als 1 mm.
<b>5</b>	Protección contra el polvo	Protected against dust	Protection contre les poussières	Protezione contro la polvere	Staubgeschützt.
<b>6</b>	Totalmente protegido contra el polvo	Fully protected against dust.	Totalement protégé contre les poussières	Totalmente protetto contro la polvere.	Staubgeschützt.
	2a cifra, protección contra la penetración de agua	2nd figure, protection against water infiltration	2ème chiffre, protection contre l'infiltration d'eau	2a cifra, protezione contro l'infiltrazione di acqua	2. Kennziffer: Schutz gegen Wassereintritt
<b>0</b>	Ninguna protección	No protection	Sans protection	Nessuna protezione	Ungeschützt
<b>1</b>	Protección contra caída vertical de gotas de agua	Protected against drops of water falling vertically	Protection contre les chutes verticales de gouttes d'eau.	Protezione contro la caduta in verticale di gocce d'acqua	Geschützt gegen senkrecht fallendes Tropfwasser.
<b>2</b>	Protección contra caída vertical de gotas de agua, 15° máx. inclinación	Protected against drops of water at a max. inclination of 15 degrees	Protection contre les chutes verticales de gouttes d'eau avec angle d'inclinaison max. de 15°	Protezione contro la caduta in verticale di gocce d'acqua con angolo di inclinazione max di 15°	Geschützt gegen schräg fallendes Tropfwasser mit einem Winkel bis zu 15°
<b>3</b>	Protección contra caída vertical de gotas de agua, 60° máx. inclinación	Protected against drops of water at a max. inclination of 60 degrees	Protection contre les chutes verticales de gouttes d'eau avec angle d'inclinaison max. de 60°	Protezione contro la caduta in verticale di gocce d'acqua con angolo di inclinazione max di 60°	Geschützt gegen schräg fallendes Tropfwasser mit einem Winkel bis zu 60°
<b>4</b>	Protección contra salpicaduras de agua procedentes de todas direcciones.	Protection against splash water from all directions.	Protection contre les projections d'eau provenant de toutes les directions.	Protezione contro gli spruzzi d'acqua provenienti da tutte le direzioni.	Schutz gegen Spritzwasser aus allen Richtungen.
<b>5</b>	Protección contra chorros de agua.	Protected against jets of water	Protection contre les projections d'eau.	Protezione contro i getti d'acqua	Geschützt gegen Strahlwasser.
<b>6</b>	Protección contra olas de agua	Protected against waves	Protection contre les vagues d'eau.	Protezione contro le ondate d'acqua	Geschützt gegen Seewellen
<b>7</b>	Protección contra inmersión	Immersion protected	Protection contre l'immersion	Protezione contro l'immersione	Eintauchgeschützt
<b>8</b>	Protección contra inmersión prolongada	Protected against long term immersion	Protection contre l'immersion prolongée.	Protezione contro l'immersione prolungata.	Geschützt gegen dauerhaftes Eintauchen



Toda la información en este catálogo sirve simplemente como una indicación y no es vinculante para la empresa. La empresa se reserva el derecho de modificar o variar los productos para mejoras técnicas o estéticas sin previo aviso. Las marcas y los logotipos pertenecen a sus legítimos propietarios.

All information in this catalogue merely serves as an indication and it is not binding for the company. The company reserves the right to modify any contents or information, even without prior notice. Brand names and logos belong to their legitimate owners.

Toutes les informations contenues dans ces catalogues ont une valeur indicative, et ne s'entendent pas contraignantes pour l'entreprise. La société se réserve le droit de modifier tout contenu ou information, en y apportant des améliorations techniques et visuelles, y compris sans communication préalable. Les marques et logos sont propriété de leurs dépositaires légitimes.

Alle Angaben in diesem Katalog dienen lediglich als Hinweis und sind für das Unternehmen nicht verbindlich. Das Unternehmen behält sich das Recht vor, Inhalte oder Informationen auch ohne vorherige Ankündigung zu ändern, um technische oder ästhetische Verbesserungen zu erreichen. Markennamen und Logos gehören ihren rechtmäßigen Eigentümern.

Tutte le informazioni presenti in questo catalogo sono soltanto indicative e non sono vincolanti per l'azienda. La società si riserva il diritto di modificare o effettuare variazioni sui prodotti per miglioramenti tecnici o estetici senza preavviso. I marchi e i loghi appartengono ai legittimi proprietari.

*Los diseños que contiene este catálogo de la empresa española con CIF B96498233, están registrados y protegidos por la Ley de Protección de Diseño Industrial.*

*All designs included in this catalogue from the Spanish Company with CIF B96498233, being registered and protected by the Industrial Design Protection Law.*

© Copyright. 2025 CIF B96498233

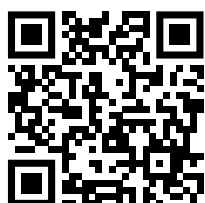

Vento pdf

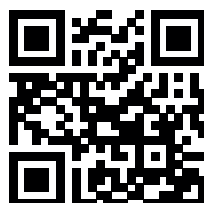

<https://acb.lighting>

---

**NACIONAL**

TEL.: +34 962 779 021

[comercial@acbiluminacion.com](mailto:comercial@acbiluminacion.com)

**EXPORT**

TEL.: +34 962 779 166

[export@acbiluminacion.com](mailto:export@acbiluminacion.com)



ACB | *Vento!*



**ACB ILUMINACION, S.L.**

Camino de valencia 104, CP. 46190, Ribarroja del Turia (Valencia) España.

<https://acb.lighting>